

An Efficient Noise Reduction Technique by Using Spectral Subtraction and DWT

K.Mallikarjuna Reddy

PG Schlor.

Dept of ECE,

**Sri Chaitanya Institute of Engineering and
Technology, A.P.**

Y.C.Ramakrishna, M.Tech

Assistant Professor,

Dept of ECE,

**Sri Chaitanya Institute of Engineering and
Technology, A.P.**

Abstract:

Wavelet transform is an important tool used in many application areas. This paper proposed the analysis of noise reduction techniques which are based on wavelet transform. In this paper three noise reduction techniques based on wavelet transform are described. These methods are Wavelet Split Coefficient; Hard Thresholding and Soft Thresholding. MATLAB GUI is developed for visualization of results which are obtained by using different techniques. With the help of these methods speech enhancement can be achieved. Due to this quality of speech can be improved with high efficiency. This wavelet transform can also be used to remove noise and blurring present in the image. In other words it is also effective in image processing to remove noise

INTRODUCTION:

Wavelet transform is most important tool which is used by many researchers to analyze the different types of signals. The wavelet transform provides the time-frequency representation of signal. Hence user can get information about the time and frequency simultaneously. Short-time Fourier transform (STFT) also provides information of both time and frequency but there are some limitations since it uses sliding window mechanism. The length of sliding window provides limitations on use of Short-time Fourier transform. But wavelet transform provides solution to this problem and hence nowadays it is widely used. Basically there are two basic types of wavelet transform. One type of wavelet transform is reversible that means original signal can be recovered back after it has been transformed.

In second case there is no need to get back original signal that is original signal cannot be recovered after it has been transformed. There are many areas in which this wavelet transform is tremendously used. This transform is widely used in field of signal processing and image processing. In these two fields wavelet transform is used to remove the noise present in the signals and to remove blurring present in an image. Wavelet transform is also used in speech enhancement. Speech plays an important role in multimedia system. Hence it is very important to remove the noise present in speech signals and for this application wavelet transform is best tool. The wavelet transform has become a useful computational tool for a variety of signal and image processing applications proposes a Hue preserving algorithm, which uses a derived mapping function to modify the Saturation components, and CLAHE for Luminance components.

TYPES OF SPEECH ENHANCEMENT:

Speech enhancement methods are of different types. User needs to select appropriate speech enhancement techniques depending on application. The speech enhancement techniques can broadly classified based on number of channel used. So there are two different types of speech enhancement techniques as follows:

- a) Single Channel Speech Enhancement**
- b) Multi- Channel Speech Enhancement**

a) Single Channel Speech Enhancement:

Single channel speech enhancement is particularly used where an alternate channel is not available for transmission of information from source to destination.

Advantage: These methods are easy to implement and less costly.

Disadvantage: Since there is no reference signal present, preprocessing of signal is not possible. Preprocessing of signal is not possible.

b) Multi- Channel Speech Enhancement:

These methods are widely used than single channel speech enhancement. In this type of speech enhancement techniques there is availability of more than single channel for transmission of signal from one place to other.

Advantage: Since reference signal is present, preprocessing of signal is possible.

Disadvantage: These systems are more complex.

I. NOISE REDUCTION METHODS:

There are different methods which are based on wavelet Transform and are used in speech for noise cancellation. Some of the noise cancellation methods are described in this paper. Every method has its own advantages and also has some Disadvantages. Selection of proper method should be based on user application and his demand. So these methods are as Follows:

A.WAVELET SPLIT COEFFICIENT METHOD:

The wavelet split coefficient method is also known as wavelet shrinkage method. This method is widely used for removing the noise present in speech signals. In short it is used for de-noising the speech signal. In this technique the wavelet coefficients are compared with the threshold. The threshold is to be set by user depending on its requirement. To get high efficiency fixing of proper threshold is very important. There are two types of thresholding techniques. These techniques are described as follows.

B. HARD THRESHOLDING:

White noise is the most difficult to detect and to remove. White noise can be handled either by hard and soft thresholding [3]. In hard thresholding all the wavelet coefficients below the given threshold value are set to zero. Hence some kind of nonlinearity is present in hard thresholding. So all types of noises cannot be removed in hard thresholding. Hard thresholding is the simplest method. The main advantage of this method is it is easy to implement and simple method. This is shown in Fig.1.

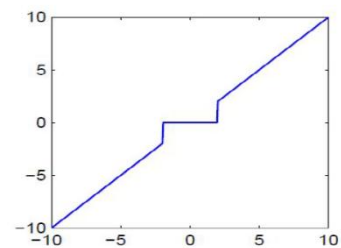

Fig.1: Hard threshold function

C. SOFT THRESHOLDING:

Soft thresholding is an extension of hard thresholding, In this method first setting to zero the elements whose absolute values are lower than the threshold, and then shrinking the nonzero coefficients towards 0 is done [3]. Hard thresholding is the simplest method but soft thresholding has nice mathematical properties and gives better de-noising performance. Nonlinearity which is present in hard thresholding is removed by using soft thresholding. This is

Shown in Fig.2

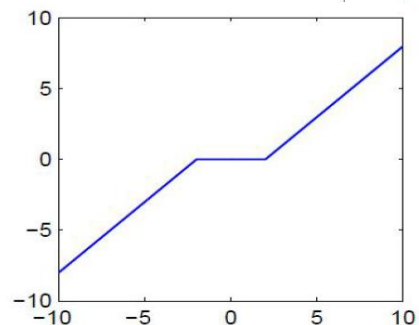

Fig.2: Soft threshold function

D. SPECTRAL SUBTRACTION:

Spectral subtraction is one of the most important algorithms used for removal of background noise. In this method the noisy signal that is original signal that is contaminated with noise is subtracted with known estimated noise spectrum. This method can be represented as follows:

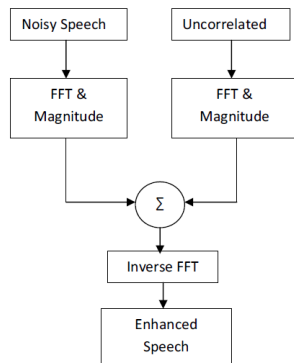

Fig.3: Spectral subtraction speech enhancement

IV. IMPLEMENTATION OF DENOISING ALGORITHM USING WAVELET TRANSFORM:

Wavelet transform is used in many application areas. Use of this wavelet transform in speech for noise cancellation is explained with the help of following algorithm. When wavelet transform is to be used for noise cancellation in speech then there are certain steps, which user must follow in order to get accurate and noise free output. These steps are as follows: The general wavelet de-noising procedure is as follows.

- [1] Apply wavelet transform to the noisy signal to produce the noisy wavelet
 - [2] Select appropriate threshold limit and threshold method (hard or soft thresholding) to best remove the noises.
 - [3] Take inverse wavelet transform of the threshold wavelet coefficients to obtain a de-noised signal.
- These steps are represented with the help of algorithm

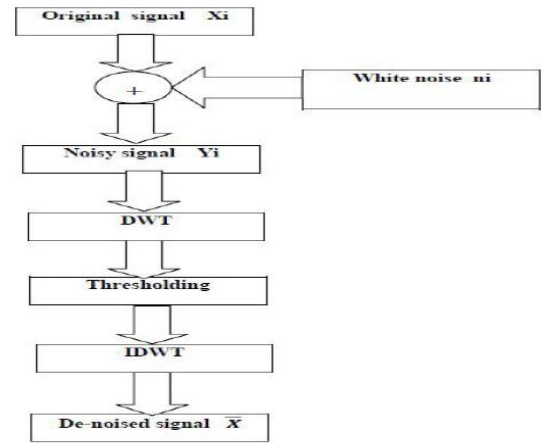

Fig.4: Denoised algorithm

To illustrate this algorithm let us take an example. Suppose we have noisy signal which is obtained by adding white noise in original signal. Fig.4 represents original signal. While Fig.5 represents signal obtained after adding white noise i.e. noisy signal.

Graphical User Interface:

- A graphical user interface (GUI) is a user interface built with graphical objects,
- such as buttons, text fields, sliders, and menus
- Applications that provide GUIs are generally easier to learn and use since the
- person using the application does not need to know what commands are
- available or how they work
- The action that results from a particular user action can be made clear by the design of the interface

For better understanding of all de-noising techniques MATLAB Graphical user interface is developed. With the help of this MATLAB Graphical user interface all the De-noising techniques can be compared visually as well as by system.

Result:

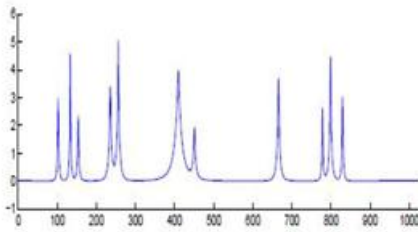

Fig.5: Original noise-free signal

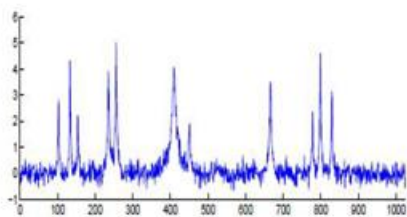

Fig.6: Noisy signal

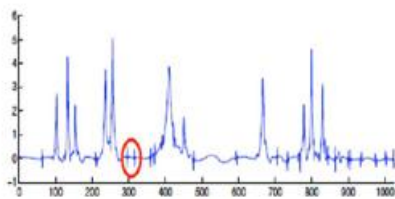

Fig.7: Processed signal (hard threshold)

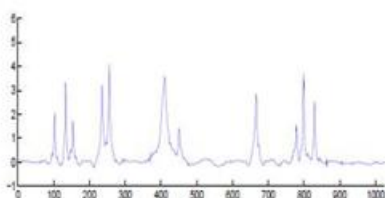

Fig.7: Processed signal (soft threshold)

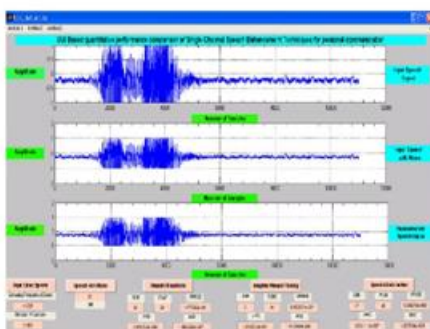

Fig.8: MATLAB Graphical User Interface

V. CONCLUSION:

This paper presents a highly efficient method of noise reduction using wavelet transform. These methods include - "WAVELET SPLIT COEFFICIENT method", "HARD THRESHOLDING" and "SOFT THRESHOLDING". Using these methods de-noising of speech signal has been achieved successfully. This paper provides practical approach on how noise can be removed with the help of three different techniques and also presents it with the help of algorithm and graphical representation. Implementation of MATLAB GUI will also help to visualize and compare the performance of different techniques.

References:

- [1] Roopali Goel, Ritesh Jain. Speech signal noise reduction by wavelets, vol-2march 2013
- [2] Mohammed bahoura, Jean rouat .Wavelet noise reduction: application to speech enhancement.
- [3] Rajeev aggarwal, Jay singh, Vijay gupta, Dr. Anubhutikhare. Elimination of white noise from speech signal using wavelet transform by soft and hard thresholding, IJEECE, vol.1(2), 2011.
- [4] YANG Dali, XU mingxing, Wu wenhu , ZHENG fang. A noise cancellation method based on wavelet transform, oct 13-15,2000
- [5] Ivan Selesnick. Wavelet transform -- a quick study, sept 27,2007.
- [6] Xiaolong Yuan. Auditory Model-based Bionic Wavelet Transform, may 2003
- [7] Ningping Fan, Radu Balan, Justinian Rosca. Comparison of Wavelet and FFT Based Single Channel Speech Signal Noise Reduction Techniques..
- [8] Adrian E. Villanueva- Luna, Alberto Jaramillo-Nuñez.