

## Design and Implementation of Automated Blood Bank Using Embedded Systems

**G.S.Satyagowry, M.Tech**

Assistant Professor,

Siddhartha Institute of Technology and Science.

**Koneti Kavitha**

M.Tech Student,

Siddhartha Institute of Technology and Science.

### Abstract

*Every year the nation requires about 4 Crore units of blood, out of which only a meager 40 Lakh units of blood are available. There are multiple blood banks around the world, however none of them offer the capability for a direct contact between the donor and recipient. This is often a serious disadvantage notably in cases wherever there is associate degree pressing would like of blood. This project aims to beat this communication barrier by providing an immediate link between the donors.*

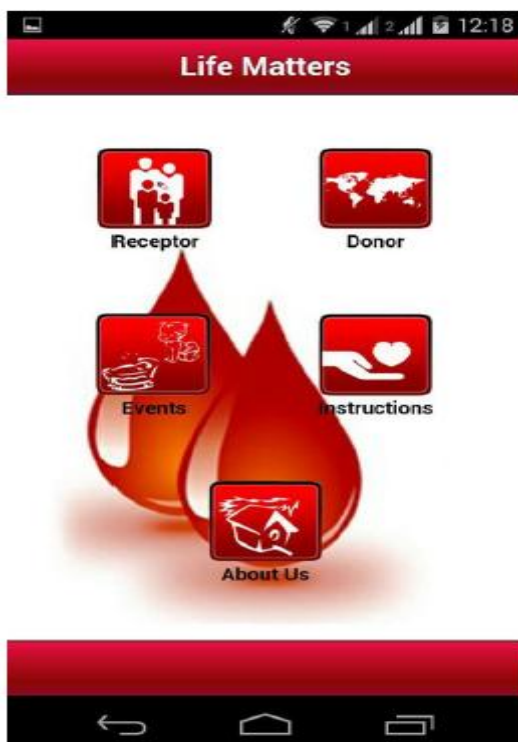

between the donor and recipient. This is a major drawback particularly in cases where there is an urgent need of blood. Our project aims to overcome this communication barrier by providing a direct call routing technique using Asterisk hardware. A blood bank database is created by collection of details from various sources like Blood banks, NSS, NGO's, hospitals and through web interface. The data collected will be maintained in a central server. This central server will be associated with a Toll free number that can be used to connect to it. The willingness of donor and the closeness of the donor to the place from where the call is coming are also accounted for in defining this algorithm. Based on the algorithm the most eligible donor is found out. From the server the call from the required person is routed to the eligible donor's number. Such a system considerably cuts down on the overheads involved in referring to an online database and then calling the donors and verifying their willingness at a time when there is a critical need for the blood.

### Existing system

Blood bank management system: At present, the public can only know about the blood donation events through conventional media means such as radio, newspaper or television advertisements. There is no information regarding the blood donation programs available on any of the portal. The current system that is using by the blood bank is manual system. With the manual system, there are problems in managing the donors' records. The records of the donor might not be kept safely and there might be missing of donor's records due to human error or disasters. Besides that, errors might occur when the staff keeps more than one record for the same donor.

## II. LITERATURE SURVEY

Automated online blood bank database: A number of online blood bank databases are available, however none of them offer the capability for a direct contact

There is no centralized database of volunteer donors. So, it becomes really tedious for a person to search blood in case of emergency. The only option is to manually search and match donors and then make phone calls to every donor. There is also no centralized database used to keep the donors' records. Each bank is having their own records of donors. If a donor makes donation in different hospital, no previous records can be traced except if the donor brings along the donation certificate. Hence, the donor is considered to be a first timer if they make blood donation in a new place. Without an automated management system, there are also problems in keeping track of the actual amount of each and every blood type in the blood bank. In addition, there is also no alert available when the blood quantity is below its par level or when the blood in the bank has expired.

### Proposed system

All communication takes place via SMS (Short Messaging Service) which is compatible with almost all mobile types. "Automated Blood Bank" proposes to bring voluntary blood donors and those in need of blood on to a common platform. This project is originated on an android APP, this will help to find the donors. Blood donor will participate in donor list using APP. Suppose if any need in blood, will get the donor list in this APP. Here in this APP, only 3 Blood group (A+, B+, O+) Data base is established. The recent interested donor number will be available in the data base. This project uses GSM modem interfaced to the controller i.e LPC2148. GSM is interfaced through the MAX232 to the Controller.

Block Diagram

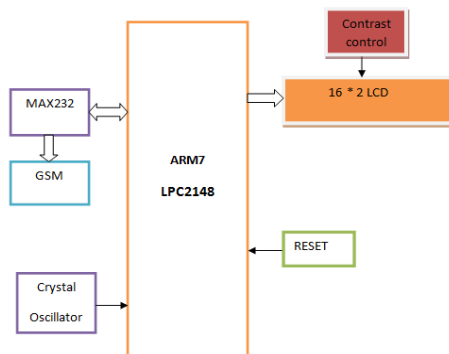

This project uses regulated 5V, 500mA power supply. 7805 three terminal voltage regulator is used for voltage regulation. Bridge type full wave rectifier is used to rectify the ac output of secondary of 230/12V step down transformer.

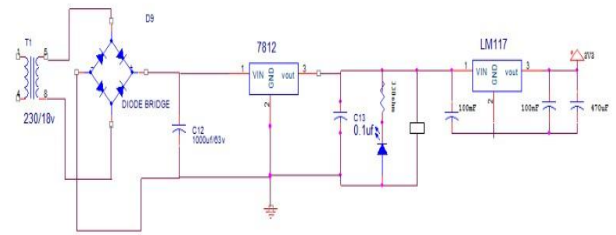

Donor Number Data base

A+	_____
B+	_____
C+	_____

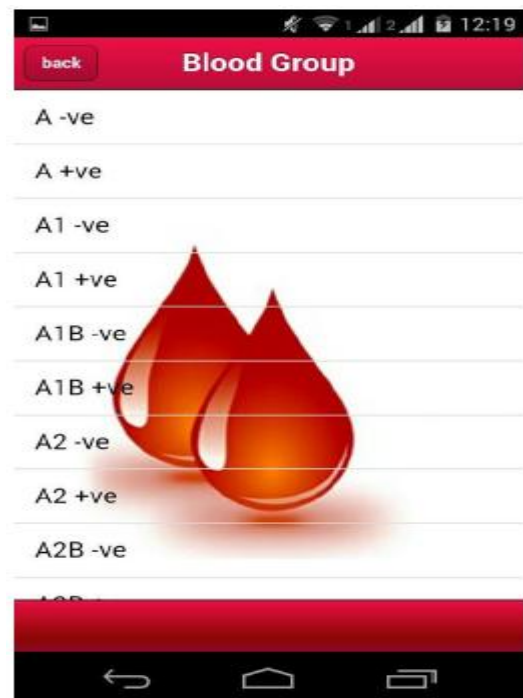

The LPC2148 are based on a 16/32 bit ARM7TDMI-S™ CPU with real-time emulation and embedded trace support, together with 128/512 kilobytes of embedded high speed flash memory.

### Pin diagram

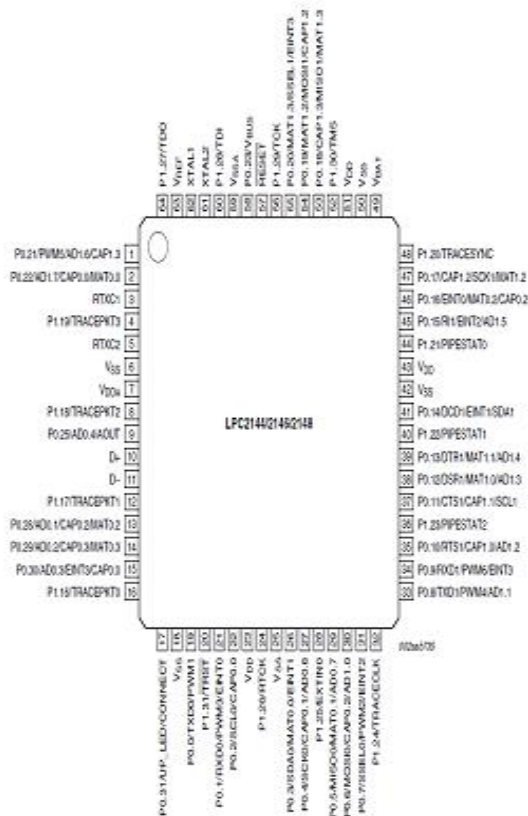

A 128-bit wide memory interface and unique accelerator architecture enable 32-bit code execution at maximum clock rate. For critical code size applications, the alternative 16-bit Thumb Mode reduces code by more than 30% with minimal performance penalty. With their compact 64 pin package, low power consumption, various 32-bit timers, 4- channel 10-bit ADC, USB PORT, PWM channels and 46 GPIO lines with up to 9 external interrupt pins these microcontrollers are particularly suitable for industrial control, medical systems, access control and point-of-sale. With a wide range of serial communications interfaces, they are also very well suited for communication gateways, protocol converters and embedded soft modems as well as many other general-purpose applications.

### Global System for Mobile Communication (GSM)

#### Definition:

GSM, which stands for Global System for Mobile communications, reigns (important) as the world's most widely used cell phone technology. Cell phones use a cell phone service carrier's GSM network by searching for cell phone towers in the nearby area. Global system for mobile communication (GSM) is a globally accepted standard for digital cellular communication.

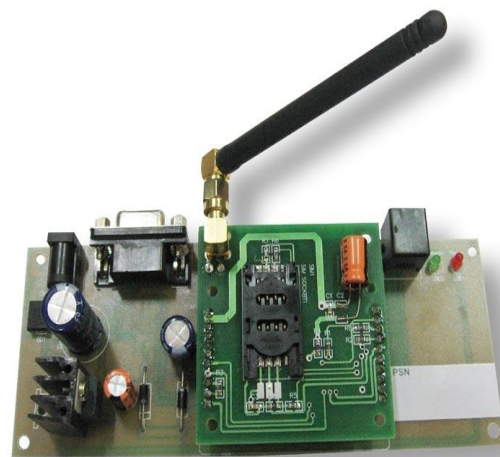



### Software tools

Keil compiler is software used where the machine language code is written and compiled. After compilation, the machine source code is converted into hex code which is to be dumped into the microcontroller for further processing. Keil compiler also supports C language code.

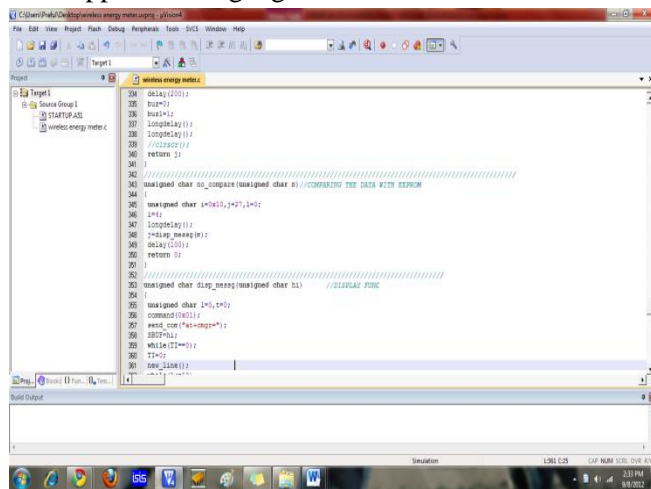

### Facts about the blood supply

Blood cannot be factory made - it will solely return from generous donors. Type O-negative blood (red cells) can be transfused to patients of all blood sorts. It is forever in great demand and sometimes in brief offer. Type AB-positive plasma can be transfused to patients of all different blood sorts. AB plasma is additionally typically in brief offer. Facts concerning the blood donation method. Donating blood could be a safe method. A sterile needle is employed one time for every donor and so discarded.

Blood donation may be an easy straightforward four-step process: registration, case history, donation and refreshments. Every blood donor is given a mini-physical, checking the donor's temperature, pressure, pulse and Hb to guarantee it is safe for the donor to administer blood. The actual blood donation usually takes less than 10-12 minutes. The whole method, from the time arrives to the time to go away, takes concerning Associate in Nursing hour and 15 min. The average adult has concerning 10 units of blood in his body. Roughly 1 unit is given throughout a donation.

A healthy donor might give red blood cells each 56 days, or double red cells each 112 days. A healthy donor might give platelets as few as 7 days apart, however a most of 24 times a year. All given blood is tested for HIV, hepatitis B and C, syphilis and different infectious diseases before it can be transfused to patients

### CONCLUSION

Blood is the primary necessity of life. There are different scenarios available for searching blood donors. This proposed system will be one step ahead from the other blood donation systems. Blood recipient can contact the blood donor directly by using this system.

### REFERENCES

- [1] Arif. M. Sreevas. S. Nafseer. K. and Rahul. R., „Automated online Blood bank database“, India Conference (INDICON), Annual IEEE, Print ISBN: 978-1-4673-2270-6, pp. 012 – 017, 2012.
- [2] BalaSenthilMurugan L, Anitha Julian, “Design and Implementation of Automated Blood Bank using Embedded Systems”, International Conference on Circuit, Power and Computing Technologies [ICCPCT], 2015.
- [3] Kapicak L, Nevlud P, Zdrlek J, Dubec P, Plucar J, "Remote control of Asterisk via Web Services", 34th International Conference on Telecommunications and Signal Processing (TSP), 2011.
- [4] Peter Marbach, Oliver Mihatsch, and John N.Tsitsiklis, "Call Admission Control and Routing in Integrated Services Networks Using Neuro-Dynamic Programming", IEEE Journal on selected areas in communications, VOL.18, NO.2, February 2000.
- [5] R Vanitha M.E, P Divyarani, “BCloud App: Blood Donor Application for Android Mobile”, International Journal of Innovations in Engineering and Technology (IJJET), Vol. 2 Issue 1 February 2013.



[6] Nader Moayeri, Jalal Mapar, Stefanie Tompkins, KavehPahlavan, "Emerging opportunities for localization and tracking", IEEE Wireless Communications, April 2011.

[5]. Ibrahim. M. and Youssef, M. (2013), 'Enabling wide deployment of GSM localization over heterogeneous phones', Communications (ICC), IEEE International Conference, ISSN: 1550-3607, pp. 6396 - 6400.

[6]. Karan Punjabi, Pooja Bolaj, Pratibha Mantur, and Sneha Wali (2014), 'Bus Locator via SMS Using Android Application', (IJCSIT) International Journal of Computer Science and Information Technologies, ISSN: 0975-9646, Vol. 5 (2), pp. 1603-1606.

[7]. Mohamed Ibrahim and Moustafa Youssef (2011), 'A Hidden Markov Model for Localization using Low-End GSM Cell Phone', Communications (ICC), IEEE International Conference, ISSN: 1550-3607, E-ISBN: 978-1-61284-231-8, Print ISBN: 978-1-61284-232-5, pp. 1 - 5.

[8]. Neetesh Saxena, and Narendra S. Chaudhari, (2014), 'EasySMS: A Protocol for End-to-End Secure Transmission of SMS', IEEE Transactions on information forensics and security, VOL. 9, NO. 7, ISSN: 1556-6013, pp. 1157 - 1168.

[9]. Spyropoulos. B., Botsivaly. M., Tzavaras. A., and Spyropoulou, P (2009), 'Towards digital blood-banking', ITU-T Kaleidoscope: Innovations for Digital Inclusions, .K-IDI. E-ISBN : 978-92-61-12891-3, Print ISBN: 978-92-61-12891-3, pp.I- 8.