

## Traffic Sign Recognition using Matlab for Advanced Driver Assistance

**N.Nagendra Babu**

M.Tech Student,  
Scient Institute of Technology,  
Hyderabad.

**L.Nagaraju, M.Tech**

Assistant Professor,  
Scient Institute of Technology,  
Hyderabad.

**V.Nagamahesh, M.Tech**

Assistant Professor & HOD,  
Department of ECE,  
Scient Institute of Technology,  
Hyderabad.

### Abstract:

Many a times the warning sign on the road sides becomes difficult to watch for the drivers and the driver may sometimes miss the warning notes. These warning notes may be speed breaker ahead or narrow bridge or even accident zone etc. This becomes tedious during many times and at nights. Sometimes because of the traffic or the road condition driver may not read anything and even if he tries to read it with a wide eye there is a chance for the drive to lose concentration on the road. This project aims at developing a solution for this problem using image processing technique. By placing a camera in front of the vehicle, it can pick road signs and give it to a system that processes the image. The image is de-noised and edge detection and shape parameters are used to identify the nature of the signs displayed. The MATLAB program identifies the signs and informs about the signs to the hardware below. Microcontroller based hardware is placed inside the vehicle. The microcontroller at all times receives the information and displays the information using the dedicated LCD display. Further the same is used to announce to the driver about the hurdles such as speed breakers. This voice alerting system helps the drivers to concentrate on the road without even worrying about the sign boards near the road. The sign recognition is done using image processing tools on a MATLAB.

The result of the recognition can be used for the application. Thus the project can be highly helpful to drivers and the voice announcement can be in any language including Tamil, English or Hindi. As this project uses image processing no additional components are necessary to be placed on the sign boards and the existing sign boards can be kept as it is. Only the vehicle need to be fitted with this system but this can be left to the vehicle manufacturers and owners and they can use it as an extra feature for safety and to prevent accidents.

### IMAGE ACQUISITION TOOL BOX:

Acquiring Image Data Image Acquisition Toolbox supports several modes, including background acquisition and continuous acquisition, while processing the acquired data. The toolbox automatically buffers data into memory, handles memory and buffer management, and enables acquisition from an ROI. The image acquisition engine is designed to acquire imagery as fast as your camera and computer can support, enabling analysis and processing of high-speed imaging applications. Data can be acquired in a wide range of data types, including signed or unsigned 8-, 16-, and 32-bit integers and single- or double-precision floating point. The toolbox supports any color space provided by the image acquisition device including RGB, YUV, or grayscale. Raw sensor data in a Bayer pattern can be automatically converted into RGB data.



**FIG:IMAGE ACQUISITION**

## Traffic sign Recognition:

At the present time, many studies are being conducted working toward the implementation of an Intelligent Traffic System (ITS). One field of this research is driving support systems, and many studies are being conducted to develop systems which identify and recognize road signs in front of the vehicle, and then use this information to notify the driver or to control the vehicle [1-9]. Development of a system which can provide road information to the driver at any time is already underway. This system uses wireless communication with special narrowband signal transmitters installed on the roadside, a technology which has already been commercialized with ETC. With the construction of this type of infrastructure, it is believed that there will be a change in the method of providing road sign information from the current method of providing visual information. However, much time will be required before this infrastructure covers all roads in local areas, and it is likely that as long as vehicles are driven by human drivers, road signs will never disappear as a means of providing traffic information.

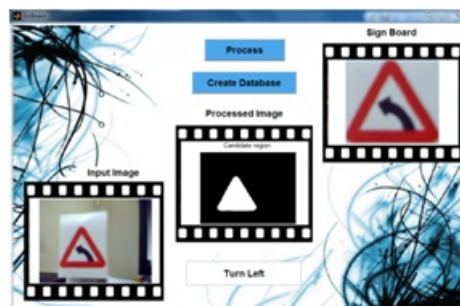
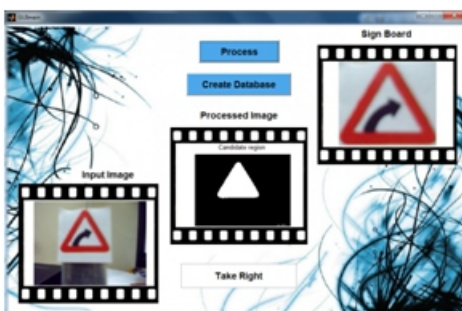

## ARM PROCESSOR:

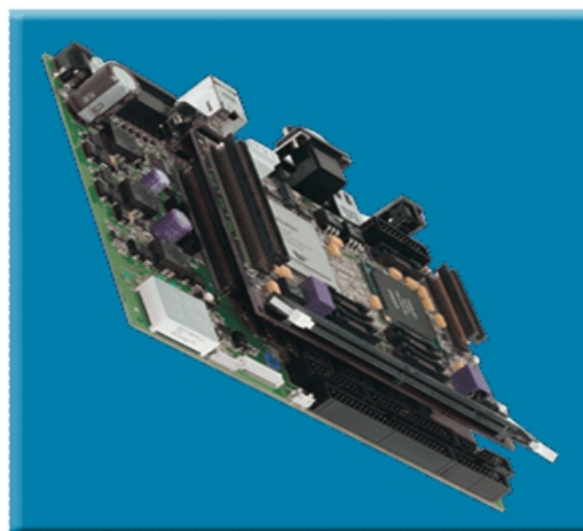

### ARM7TDMI Processor Core

- Current low-end ARM core for applications like digital mobile phones
- TDMI
  - oT: Thumb, 16-bit compressed instruction set
  - oD: on-chip Debug support, enabling the processor to halt in response to a debug request
  - oM: enhanced Multiplier, yield a full 64-bit result, high performance
  - oI: Embedded ICE hardware
- Von Neumann architecture

The LPC2148 are based on a 16/32 bit ARM7TDMI-S™ CPU with real-time emulation and embedded trace support, together with 128/512 kilobytes of embedded high speed flash memory. A 128-bit wide memory interface and unique accelerator architecture enable 32-bit code execution at maximum clock rate.

For critical code size applications, the alternative 16-bit Thumb Mode reduces code by more than 30% with minimal performance penalty. With their compact 64 pin package, low power consumption, various 32-bit timers, 4- channel 10-bit ADC, USB The LPC2148 are based on a 16/32 bit ARM7TDMI-S™ CPU with real-time emulation and embedded trace support, together with 128/512 kilobytes of embedded high speed flash memory.

A 128-bit wide memory interface and unique accelerator architecture enable 32-bit code execution at maximum clock rate. For critical code size applications, the alternative 16-bit Thumb Mode reduces code by more than 30% with minimal performance penalty. With their compact 64 pin package, low power consumption, various 32-bit timers, 4- channel 10-bit ADC, USB PORT, PWM channels and 46 GPIO lines with up to 9 external interrupt pins these microcontrollers are particularly suitable for industrial control, medical systems, access control and point-of-sale. With a wide range of serial communications interfaces, they are also very well suited for communication gateways, protocol converters and embedded soft modems as well as many other general-purpose applications.

BLOCK DIAGRAM

TRANSMITTER SECTION:

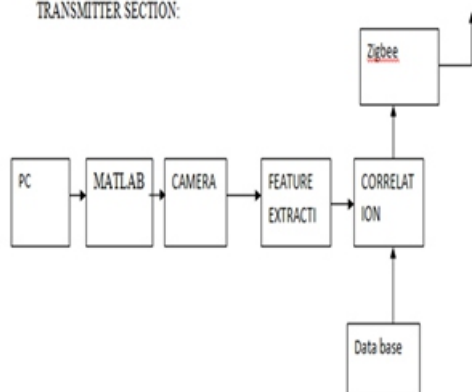

RECEIVER SECTION

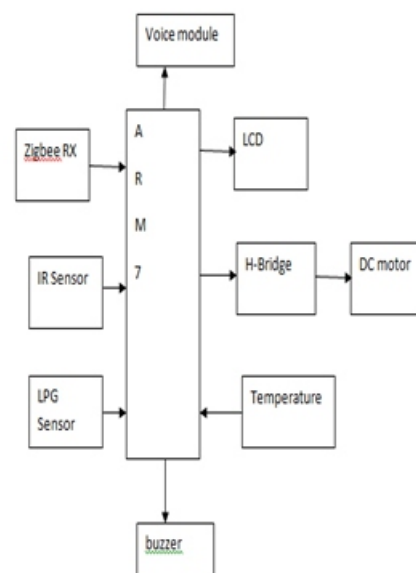

### DC MOTOR:

An electric motor is a machine which converts electrical energy into mechanical energy.

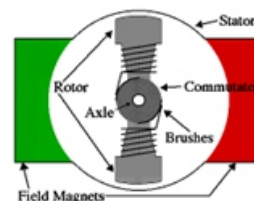

### Principles of operation:

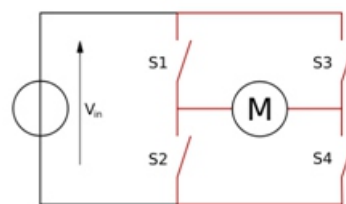

In any electric motor, operation is based on simple electromagnetism. A current-carrying conductor generates a magnetic field; when this is then placed in an external magnetic field, it will experience a force proportional to the current in the conductor, and to the strength of the external magnetic field. As you are well aware of from playing with magnets as a kid, opposite (North and South) polarities attract, while like polarities (North and North, South and South) repel. The internal configuration of a DC motor is designed to harness the magnetic interaction between a current-carrying conductor and an external magnetic field to generate rotational motion.



## ZIGBEE TECHNOLOGY:



ZigBee module. The €1 coin, shown for size reference, is about 23 mm (0.9 inch) in diameter. ZigBee is a specification for a suite of high level communication protocols using small, low-power digital radios based on the IEEE 802.15.4-2003 standard for wireless personal area networks (WPANs), such as wireless headphones connecting with cell phones via short-range radio. The technology defined by the ZigBee specification is intended to be simpler and less expensive than other WPANs, such as Bluetooth. ZigBee is targeted at radio-frequency (RF) applications that require a low data rate, long battery life, and secure networking. The ZigBee Alliance is a group of companies that maintain and publish the ZigBee standard.

## ARCHITECTURE:

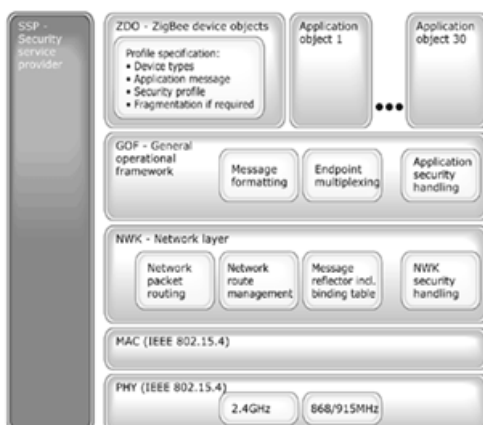

ZigBee is a home-area network designed specifically to replace the proliferation of individual remote controls. ZigBee was created to satisfy the market's need for a cost-effective, standards-based wireless network that supports low data rates, low power consumption, security, and reliability. It may be helpful to think of IEEE 802.15.4 as the physical radio and ZigBee as the logical network and application software. Following the standard Open Systems Interconnection (OSI) reference model, ZigBee's protocol stack is structured in layers. The first two layers, physical (PHY) and media access (MAC), are defined by the IEEE 802.15.4 standard. The layers above them are defined by the ZigBee Alliance. The IEEE working group passed the first draft of PHY and MAC in 2003.



## Applications of Zigbee:



## Recognition methods in image processing:

Image recognition is the process of identifying and detecting an object or a feature in a digital image or video. This concept is used in many applications like systems for factory automation, toll booth monitoring, and security surveillance. Typical image recognition algorithms include:

- Optical character recognition
- Pattern and gradient matching

- Face recognition
- License plate matching
- Scene change detection

### **Advantages:**

- Low cost implementation
- Efficient
- Human effort is reduced

### **Applications:**

- Trains
- Buses
- Cars

### **REFERENCES :**

- [1]T. Moura, J. Teixeira, F. Tuna, F. Moreira, A. Valente, V. Filipe, S. Soares. “Reconhecimento de Sinais de Trânsito para Prova de Robótica de Condução Autônoma”. Proceedings of 19th Annual Seminar on Automation, Industrial Electronics and Instrumentation (SAAEI’12), pp. 645-649, 2012.
- [2]V. Prisacariu, R. Timofte, K. Zimmermann, I. Reid, and L. Van Gool, “Integrating object detection with 3D tracking towards a better driver assistance system”, in Proc. 20th ICPR, pp. 3344–3347, August 2010.
- [3]V. Prisacariu, R. Timofte, K. Zimmermann, I. Reid, and L. Van Gool, “Integrating object detection with 3D tracking towards a better driver assistance system”, in Proc. 20th ICPR, pp. 3344–3347, August 2010.
- [4]X. Qingsong, S. Juan, and L. Tiantian, “A detection and recognition method for prohibition traffic signs”, in Proc. Int. Conf. IASP, pp.583–586, April 2010.
- [5]F. Ren, J. Huang, R. Jiang, and R. Klette, “General traffic sign recognition by feature matching”, in Proc. 24th Int. Conf. IVCNZ, pp. 409–414, November 2009.
- [6]E. Krsak, S. Toth, “Traffic sign recognition and localization for databases of traffic signs”, in Acta Electrotechnica et Informatica, vol. 11, no. 4, pp. 31-35, 2011.
- [7]S. Houben, “A single target voting scheme for traffic sign detection”, in Proc. IEEE IV Symp., pp. 124–129, June 2011.
- [8]S. Xu, “Robust traffic sign shape recognition using geometric matching”, IET Intell. Transp. Syst., vol. 3, no. 1, pp. 10–18, March 2009.
- [9]F. Larsson and M. Felsberg, “Using Fourier descriptors and spatial models for traffic sign recognition”, in Proc. Image Anal., pp. 238–249, 2011.
- [10]D. Pei, F. Sun and H. Liu, “Supervised Low-Rank Matrix recovery for Traffic Sign Recognition in Image Sequences”, IEEE Signal Processing Letters, vol. 20, no. 3, March 2013.